

PROTEIN EXPRESSION & ANALYSIS

PURExpress[®]
In Vitro Protein Synthesis

Instruction Manual

NEB #E6800S/L, #E3313S
#E6840S, #E6850S
Store at -80°C

 NEW ENGLAND
BioLabs[®] Inc.
enabling technologies in the life sciences



Table of Contents:

Kit Components	2-3
Introduction	5
Overview	5
Considerations for Template Preparation	6
Generation of Template DNA by PCR	8
Protocols	9-17
Protein Synthesis Reaction	9
Analysis of Synthesized Protein	12
Measurement of ³⁵ S-Methionine Incorporation by TCA Precipitation and Yield Determination	14
Purification of Synthesized Protein – Reverse His-Tag Purification	16
Troubleshooting	18
Citations	20
Ordering Information	24

Kit Components:

All kit components should be stored at **-80°C**.

Each kit contains sufficient reagents for 10 x 25 µl reactions (NEB #E6800S, #E3313S, #E6840S, #E6850S) or 100 x 25 µl reactions (NEB #E6800L).

PURExpress *In Vitro* Protein Synthesis Kit (NEB #E6800)

Solution A (Yellow) ●

Thaw on ice just before use.

Avoid multiple freeze-thaw cycles, if possible. Aliquot as necessary.

Solution B (Red) ●

Thaw on ice just before use.

Avoid multiple freeze-thaw cycles, if possible. Aliquot as necessary.

DHFR Control Template

Plasmid DNA (125 ng/µl) encoding *E. coli* dihydrofolate reductase for use as a positive control.

PURExpress Δ Ribosome Kit (NEB #E3313)

Solution A (Yellow) ●

Thaw on ice just before use.

Avoid multiple freeze-thaw cycles, if possible. Aliquot as necessary.

Factor Mix

Thaw on ice just before use.

Control Ribosomes – *enough for two 25 µl reactions only*

Thaw on ice just before use.

DHFR Control Template

Plasmid DNA (125 ng/µl) encoding *E. coli* dihydrofolate reductase for use as a positive control.

PURExpress Δ (aa, tRNA) Kit (NEB #E6840)

Solution A (minus aa, tRNA)

Thaw on ice just before use.

Avoid multiple freeze-thaw cycles, if possible. Aliquot as necessary.

Solution B (Red) ●

Thaw on ice just before use.

Avoid multiple freeze-thaw cycles, if possible. Aliquot as necessary.

Amino Acid Mixture

***E. coli* tRNA**

DHFR Control Template

Plasmid DNA (125 ng/ μ l) encoding *E. coli* dihydrofolate reductase for use as a positive control.

PURExpress Δ RF123 Kit (NEB #E6850)

Solution A (Yellow) ●

Thaw on ice just before use.

Avoid multiple freeze-thaw cycles, if possible. Aliquot as necessary.

Solution B (minus RF1, RF2, RF3)

Thaw on ice just before use.

Avoid multiple freeze-thaw cycles, if possible. Aliquot as necessary.

RF1

Thaw on ice just before use.

RF2

Thaw on ice just before use.

RF3

Thaw on ice just before use.

DHFR Control Template

Plasmid DNA (125 ng/ μ l) encoding *E. coli* dihydrofolate reductase for use as a positive control.

Materials Not Included:

General:	37°C incubator
Labeling:	³⁵ S-Methionine (>1000 Ci/mmol recommended, <i>in vitro</i> translation grade)
TCA Precipitation:	TCA solutions (25%, 10%), 1 M NaOH, casamino acids, ethanol, glass fiber filters, vacuum filtration manifold
SDS-PAGE:	Gels and running buffer, gel apparatus, power supply, gel dryer
Western Blotting:	Transfer apparatus, membrane, antibodies and detection reagent
Purification:	Ni-NTA Agarose, Amicon Ultra- 0.5 ml, Ultracel- 100K Membrane Centrifugal Filters

Introduction:

Overview

A rapid method for gene expression analysis, PURExpress is a novel cell-free transcription/translation system reconstituted from the purified components necessary for *E. coli* translation. The relative nuclease-free and protease-free nature of the PURExpress platform preserves the integrity of DNA and RNA templates/complexes and results in proteins that are free of modification and degradation. Transcription and translation are carried out in a one-step reaction, and require the mixing of only two tubes. With results available in a few hours, PURExpress saves valuable laboratory time and is ideal for high throughput technologies.

NEB Currently Offers Four PURExpress Kits:

Product	NEB #	
PURExpress <i>In Vitro</i> Protein Synthesis Kit	#E6800	all the components are contained in two solutions (A&B)
PURExpress Δ Ribosome Kit	#E3313	ribosomes are added to the reaction separately
PURExpress Δ (aa, tRNA) Kit	#E6840	amino acids and tRNAs are provided separately
PURExpress Δ RF123 Kit	#E6850	three release factors are supplied separately

PURExpress is based on the PURE system technology originally developed by Dr. Takuya Ueda at the University of Tokyo and commercialized as the **PURESYSYEM**[®] by BioComber (Tokyo, Japan). PURExpress is an easy-to-use one-step reaction that requires the mixing of only two tubes. Protein synthesis is initiated by the addition of template DNA and is largely complete within two hours. Products of translation can be analyzed by SDS-PAGE (Coomassie stained, autoradiograph of ³⁵S-labeled proteins, or western blot) or in direct activity assays. Purification of the target protein can often be accomplished by ultrafiltration to remove the high MW ribosomes followed by IMAC (immobilized metal affinity chromatography) to remove the His-tagged components.

Due to its reconstitution of recombinant components, PURExpress is essentially free of contaminating exonucleases, RNases, and proteases. Template DNA is not exposed to digestion and target proteins are free of post-translational modifications (glycosylation, phosphorylation, and proteolysis).

Considerations for Template Preparation and Detection Methods:

PCR products, linear, or circular plasmid DNA can be used as the template DNA with PURExpress. While higher yields are often obtained with circular plasmid DNA as the template, PCR products can generate acceptable yields and can provide many timesaving advantages. The use of PCR to prepare template lends itself to projects where throughput is important, as transformation and plasmid purification steps are bypassed. PCR also affords the user the ability to modify coding or regulatory sequences (deletions, point mutations, addition of tags or other sequence elements, etc.) and prepare multiple templates at once.

Template purity is very important for successful *in vitro* transcription/translation. For best results, template DNA should be free of nucleases (DNases and RNases). Plasmid DNA prepared from many commercial kits (e.g. Qiagen) often contains inhibitory amounts of RNase A. To remove RNase, phenol:chloroform extraction and ethanol precipitation will remove the unwanted activity. For samples where RNase can't be removed, inclusion of RNase Inhibitors (e.g. NEB #M0314) to the reaction will generally provide good results.

PCR templates should be **free of non-specific amplification products** that can interfere with transcription and/or translation. We do not recommend gel purifying the templates as gel purified DNA often contains inhibitors of translation.

In general, we recommend a starting concentration of 250 ng template DNA per 25 μ l reaction. In our experience, the optimal amount will fall in a range of 25–250 ng template. Template amounts for larger or smaller reactions should be scaled up or down accordingly. Templates are usually suspended in 10 mM Tris, pH 8.0. Samples should be free of potential inhibitors, including NaCl (> 50 mM), glycerol (> 1%), EDTA (> 1 mM) and magnesium or potassium salts (> 1–2 mM).

For convenience, the DHFR control plasmid can be used as a cloning vector for target genes (see Figure 1A). This high copy vector contains the required T7 promoter, ribosome binding site, T7 terminator, and ampicillin resistance. Users can replace the DHFR gene with other genes of interest for use with *in vitro* or *in vivo* expression.

In addition to an in-frame coding sequence for the target protein, the template DNA must contain the following (see Figure 1B):

- start codon (ATG)
- stop codon (TAA, TAG, or TGA)
- T7 promoter upstream (approximately 20-100 nucleotides) of the coding sequence
- ribosome binding site (RBS, aka Shine-Dalgarno sequence) upstream (approx. 6-8 nucleotides) of the start of translation
- spacer region \geq 6 bp downstream from the stop codon (PCR products)
- T7 terminator downstream from the stop codon (recommended for plasmid DNA, linear and PCR templates)

Figure 1A: Schematic of the DHFR Control Plasmid (full sequence available online)

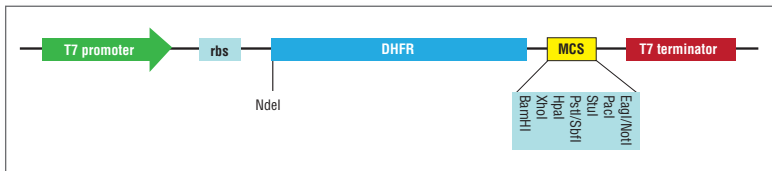
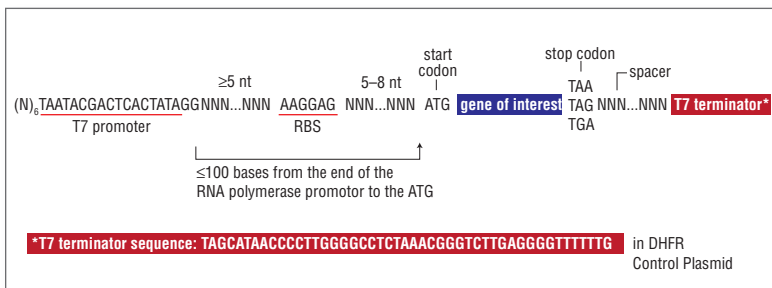

Figure 1B: Required elements for template DNA



Generation of Template DNA PCR:

PCR can be used to generate template DNA for use with PURExpress. Gene specific primers are used to add adaptor sequences (homologous to part of the regulatory region DNA) to the 5' and 3' ends of the gene of interest.

Figure 2: Suggested Primer Design for PCR

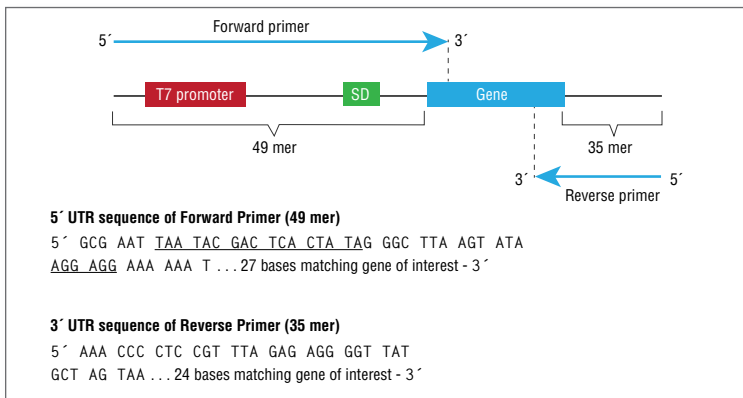
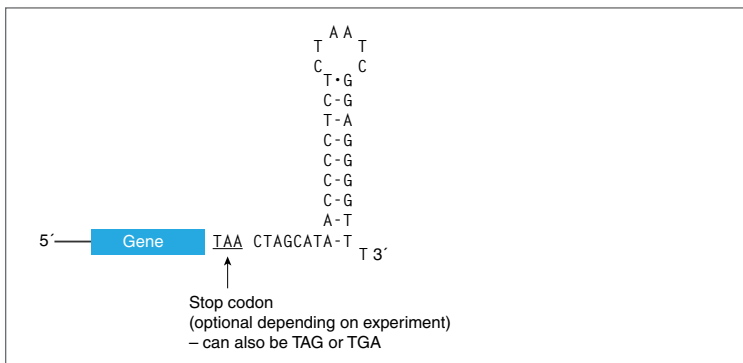

Figure 3: 3' UTR Stem Loop of PCR Templates for PURExpress



Using RNA Templates:

Although the kit is designed for coupled transcription and translation, direct translation from an mRNA template is possible. For optimal results, the amount of RNA (transcribed *in vitro* or purified from cells) needs to be determined empirically. As a starting point, we suggest using 1–5 µg mRNA template per reaction. The mRNA should contain a proper RBS for efficient translation. There is no guarantee every mRNA will be successful in translation, particularly long mRNA's. A stem loop structure at the 3' end of the gene of interest such as T7 terminator may stabilize mRNA.

Genes Under Non-T7 Control:

Genes in T3, Sp6 or *E. coli* RNAP based vectors can still be used as templates for protein synthesis by PURExpress. In these cases, add 100–200 units of T3, Sp6 or an appropriate amount of *E. coli* RNA Polymerase to the reaction.

Protocols:

Protein Synthesis Reaction

Using a positive control template to verify protein synthesis can be useful when unfamiliar with *in vitro* transcription-translation protocols. We recommend wearing gloves and using nuclease-free tubes and tips to avoid introducing nucleases to your samples. Please keep all reagents on ice before and during the assembly of reactions and avoid more than five freeze-thaw cycles of the tubes. Reactions are typically 25 µl but can be scaled down or up, as needed. Reactions are usually assembled in nuclease-free 0.5 ml microfuge tubes.

1. Thaw the necessary number of aliquots of solutions on ice.
Pulse-spin in microfuge to collect solutions to bottom of tubes.
Certain components in Solution A may precipitate during storage. Be sure to mix it well prior to assembling reactions. The performance of the kit will not be compromised. Do not vortex Solution B, mix gently.
2. Assemble the reaction on ice in a new tube in the following order:

PURExpress *In Vitro* Protein Synthesis Kit (NEB #E6800)

Solution A	10 µl
Solution B	7.5 µl
Supplements (RNase Inhibitor, ³⁵ S-met, etc.)	x µl
Nuclease-free H ₂ O	x µl
Template DNA	x µl
Total	25 µl

2. (continued)

When using one of the PURExpress Δ Kits, assemble the appropriate reaction on ice in a new tube in the following order:

PURExpress Δ Ribosome Kit (NEB #E3313S)

Solution A	10 μ l
Factor Mix	3 μ l
Ribosomes (13.3 μ M)	4.5 μ l
Supplements (RNase Inhibitor, 35 S-met, etc.)	x μ l
Nuclease-free H ₂ O	x μ l
Template DNA	x μ l
Total	25 μ l

PURExpress Δ (aa, tRNA) Kit (NEB #E6840S)

Solution A (minus aa, tRNA)	5 μ l
aa Mixture	2.5 μ l
tRNA	2.5 μ l
Solution B	7.5 μ l
Supplements (RNase Inhibitor, 35 S-met, etc.)	x μ l
Nuclease-free H ₂ O	x μ l
Template DNA	x μ l
Total	25 μ l

PURExpress Δ RF123 Kit (NEB #E6850S)

Solution A	10 μ l
Solution B (minus RF123)	7.5 μ l
RF1 (if necessary)	0.5 μ l
RF2 (if necessary)	0.5 μ l
RF3 (if necessary)	0.5 μ l
Supplements (RNase Inhibitor, 35 S-met, etc.)	x μ l
Nuclease-free H ₂ O	x μ l
Template DNA	x μ l
Total	25 μ l

These formulations allow an increase in the "user added" volume (for template, supplements, etc.); tolerating up to 20% over volume (30 μ l reaction total) without an appreciable drop in productivity.

The DHFR control template is supplied at 125 ng/ μ l. Use 2 μ l for the positive control reaction. Template DNA, particularly plasmid DNA prepared by mini-prep (e.g. Qiagen) is often the major source of RNase contamination. We strongly recommend adding 20 units RNase Inhibitor, Murine (NEB #M0314) in each reaction.

For target proteins requiring disulfide bonding, we suggest supplementing the reactions with the PURExpress Disulfide Bond Enhancer (PDBE, NEB #E6820).

Add Solution B to Solution A, do not dilute Solution B unbuffered. We recommend a starting concentration of 250 ng template DNA per 25 μ l reaction. The optimal amount of input DNA can be determined by setting up multiple reactions and titrating the amount of template DNA added to the reaction. Typically, the optimal amount will fall in a range of 25–250 ng template.

(NEB #E3313) The standard reaction contains 60 pmoles of ribosomes in a 25 μ l reaction. The supplied control ribosomes are enough for two reactions. If your ribosome concentration is 13.3 mM we suggest making up the ribosome volume to 4.5 μ l with 10 mM magnesium acetate. Using a smaller amount of ribosomes is possible but the protein yield may be lower.

3. Mix gently and pulse-spin in microfuge to collect mixture at the bottom of the tube.
4. Incubate at 37°C for 2 hours.

We recommend using an incubator rather than a water bath, to prevent evaporation. Some reactions can benefit from an additional 2 hours (4 hours total) of incubation to achieve maximum yield. Some proteins are also more soluble at reduced temperatures; however, incubating reactions below 37°C will likely reduce yield.

5. Stop the reaction by placing the tube(s) on ice.
6. Use samples for analysis or purification or freeze at –20°C for use at a later time.

Some material may precipitate during storage at –20°C. Please ensure everything is resuspended by flicking the reaction tube after thawing.

The PURExpress components are highly purified and present in known quantities. The reconstituted nature of this product makes it amenable to modifications. As such, it is easy to perform *in vitro* labeling reactions with ³⁵S-methionine to allow visualization of the product. It is also straightforward to supplement the reactions with a component under investigation that is believed to have an effect on transcription or translation. *In vitro* labeling with ³⁵S-methionine can be performed by setting up a standard reaction with the addition of 1–2 μ l (1 μ l usually sufficient) of ³⁵S-methionine.

All amino acids, including methionine, are present at 0.3 mM in PURExpress (with the exception of NEB #E6840). Labeled amino acids will compete with existing normal amino acids and the observed signal from the label depends on the efficiency of incorporation into the protein of interest. When supplemented with 1.2 μ M ³⁵S- L-methionine, we observe levels of incorporation compatible with autoradiographic detection of the synthesized protein. Reactions (1–5 μ l) can then be directly resolved by SDS-PAGE (no need for acetone precipitation), the gels are then briefly fixed in a methanol /acetic acid solution (45%/10%) for 5 minutes at 25°C and dried down onto filter paper (2 hrs at 80°C). The dried gel is then exposed to autoradiographic film (overnight at –20°C) or detected with a phosphorimager.

We encourage safe handling of radioisotopes and suggest consulting with your institution's radiation safety officer for guidelines and advice on the practical aspects of performing labeling reactions in your workplace.

Analysis of Synthesized Protein:

After *in vitro* transcription/translation, reactions can be analyzed by SDS-PAGE followed by staining with Coomassie (Figure 4), silver or other dye, western blotting or autoradiography (for labeled proteins, Figure 5). PURExpress reactions are amenable to direct analysis; there is no need to precipitate the proteins by acetone, TCA or ethanol prior to SDS-PAGE. Alternatively, if the target protein has enzymatic activity, the reaction can be used directly in the enzymatic assay provided the reaction mixture components do not interfere with the assay.

Figure 4: Protein expression using the PURExpress™ *In Vitro* Protein Synthesis Kit.

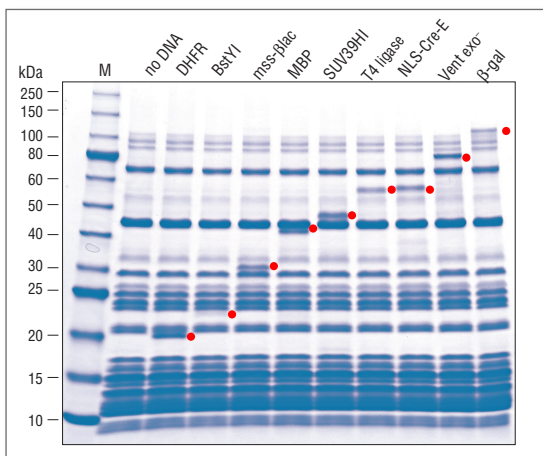

25 μ l reactions containing 250 ng template DNA and 20 units RNase Inhibitor were incubated at 37°C for 2 hours. 2.5 μ l of each reaction was analyzed by SDS-PAGE using a 10–20% Tris-glycine gel. The red dot indicates the protein of interest. Marker M is the Protein Ladder (NEB #P7703).

The yield of the target protein will vary. On average, we observe between 10–200 μ g/ml, which translates to 250–5000 ng/25 μ l reaction volume. It is useful to run a portion of the reaction on a protein gel and compare the banding pattern to a control reaction with no template DNA. The target protein is usually observed as a unique band, not present in the control reaction. Sometimes, the target has the same apparent MW as one of the endogenous proteins. In these cases, the target protein will enhance or “darken” the co-migrating band. We recommend loading 2.5 μ l of a reaction onto a mini protein gel and resolving by SDS-PAGE. Briefly, mix 2.5 μ l of a PURExpress reaction with SDS gel loading buffer and H₂O so the total volume is 10–15 μ l. Heat the sample for 2–3 minutes at 90–100°C to denature the proteins and load the sample onto a protein gel. Run the gel according to the manufacturers recommendations and stain with Coomassie Blue or other stain as directed. Proteins below 16 kDa will migrate with the majority of ribosomal proteins at the bottom of the gel.

To improve resolution in this MW range, we recommend filtering the reaction with a Amicon Ultracel 0.5 ml-100K to remove high MW ribosomes (see page 18) and running the flow-through (permeate) on the SDS gel.

If the reactions will be visualized by autoradiography (for ^{35}S -met labeled proteins) or by western blotting (for target proteins recognized by an available antibody) the amounts of reaction needed will vary and usually be less than the 2.5 μl used for Coomassie stained gels. Aliquots between 0.5–2.5 μl should be sufficient depending on the efficiency of the labeling, age of the label, or quality of the antibody. Again, we note that *in vitro* protein synthesis reactions produced by PURExpress can be directly loaded onto SDS-PAGE gels with no need for acetone precipitation and clean-up.

Figure 5: Incorporation of ^{35}S -methionine enables visualization of protein by autoradiography.

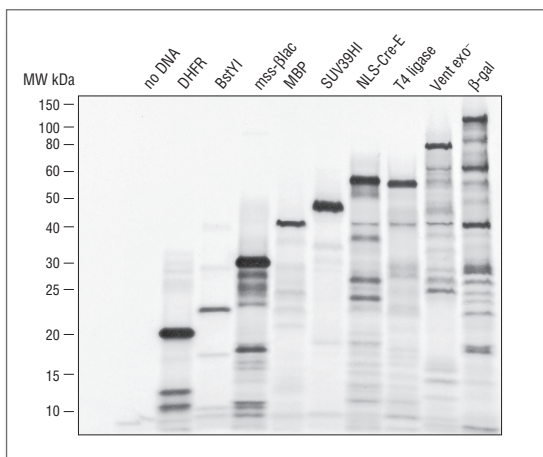

25 μl reactions containing 250 ng template DNA, 20 units RNase Inhibitor and 2 μl ^{35}S -met were incubated at 37°C for 2 hours. 2.5 μl of each reaction was analyzed by SDS-PAGE, the gel was fixed for 10 minutes, dried for 2 hours at 80°C and exposed to x-ray film for 5 hours at -80°C.

Measurement of ³⁵S-Methionine Incorporation by TCA Precipitation and Yield Determination

Using TCA to precipitate labeled protein after synthesis in the presence of ³⁵S-methionine allows the measurement of radiolabel incorporation and provides a means to estimate the amount of protein synthesized in a reaction. When compared to a reaction without template DNA (negative control reaction), the overall efficiency of the protein synthesis reaction is revealed.

1. Following incubation, mix 5 μ l of the labeled PURExpress reaction with 250 μ l of 1M NaOH in a glass test tube and incubate at RT for 10 min. NaOH will deacylate all charged tRNA's, including ³⁵S-Met-tRNA, to ensure that all TCA precipitable counts originate from labeled protein.
2. Add 2 ml cold TCA/CAA mix (25% trichloroacetic acid/ 2% casamino acids) to sample and vortex briefly. Incubate on ice for 5 min. Acidifying the solution with TCA will precipitate all the protein.
3. Use vacuum filtration to collect the precipitated protein. Pre-wet glass fiber filters with 10% TCA and transfer sample to the filter with vacuum. Rinse the tubes 3X with cold 10% TCA and transfer to the vacuum filter. Wash once with 95% ethanol to dry the filters and prevent quenching.
 - 3a) Alternatively, soak 2.5 cm glass or paper filters in 10% TCA and allow to dry. Spot 20 μ l of the base-treated reaction (step 1) on the filter and transfer to a beaker containing 100 ml ice-cold TCA and incubate w/ swirling for 15 minutes on ice. Repeat wash three times (total), then wash with ethanol and dry.
4. Place dry filters into scintillation vials with 2 ml scintillation fluid.
5. Prepare a control filter to measure the total counts in a labeling reaction. Directly pipet 5 μ l of a reaction onto a dry glass fiber filter and place the filter into scintillation fluid.
6. Measure samples in a scintillation counter. Multiply all values by 5 to determine the counts in a 25 μ l reaction. The TCA precipitated counts is a measure of the efficiency of the labeling and can be represented as a percentage of the total counts by dividing the TCA sample value by the total counts control filter value and multiplying by 100.

³⁵S is not a strong isotope. The signal may be quenched by extra salt, H₂O, etc. in the sample. We recommend recounting the samples after the filters have been soaked in the scintillation fluid for 4 hours to overnight. We find this second measurement is often more consistent and reliable.

Determination of Yield:

Using the equations below, one can calculate the yield of protein synthesized in the reaction. The calculations do not differentiate full-length protein from truncated products and as such, all translation products contribute to the calculation of yield. Prior to using the equations, it is necessary to have determined the number of picomoles of both labeled and unlabeled methionine in the reaction, the number of counts produced by no template (background), target protein (TCA-precipitable) and the total counts in a reaction.

picomoles of Met:

unlabeled	= 0.3 mM in reaction = 300 pmol/ μ l x 25 μ l rxn = 7,500 pmol
labeled	= 2 μ l of ^{35}S -Met (15 mCi/ml, 1,000 Ci/mmol) per rxn = 2 μ l x 15 mCi/ml = 30 μ Ci x μ mol/1 x 10^6 μ Ci = 3×10^{-5} μ mol = 30 pmol
total	= 7,500 pmol unlabeled Met + 30 pmol labeled Met = 7,530 pmol Met
Total counts	= total cpm per 5 μ l control x (reaction volume/5)
Specific Activity	= $\frac{\text{Total counts}}{\text{pmoles methionine (labeled and unlabeled)}}$
Met incorporation (pmoles)	= $\frac{[(\text{TCA ppt cpm} - \text{background cpm}) \times \text{total reaction volume}/5]}{\text{Specific Activity}}$
pmoles of protein	= $\frac{\text{pmoles of incorporated Met}}{\# \text{ of Met residues in target protein}}$
Yield of protein (μ g/25 μ l)	= $\frac{\text{pmoles of protein} \times \text{MW of protein}}{10^6}$

Example of Calculation:

DHFR:	17,998 Daltons, 5 methionine residues
CPM's Measured:	1.12 x 10^7 total, 5 μ l aliquot 1.8 x 10^4 background 1.95 x 10^6 TCA ppt
Total Counts	= 1.12 x 10^7 cpm x 5 = 5.6 x 10^7 cpm/25 μ l rxn
Specific Activity	= $\frac{5.6 \times 10^7 \text{ cpm}}{7530 \text{ pmol}} = 7437 \text{ cpm/pmol}$
Methionine Incorporation	= $\frac{(1.95 \times 10^6 \text{ cpm} - 1.8 \times 10^4 \text{ cpm}) \times 5}{7437}$ = 1297 pmol Met
pmoles DHFR	= $\frac{1297 \text{ pmol Met}}{5 \text{ Met/DHFR}} = 259.4 \text{ pmol DHFR}$
Yield (μ g)	= $\frac{259.4 \times 17,998}{10^6} = 4.67 \mu\text{g}/25 \mu\text{l rxn} \times 40/\text{ml}$ = 187 μ g/ml

Purification of Synthesized Protein using Reverse His-tag Purification

The following protocol is designed to rapidly purify analytical amounts of translated protein from a PURExpress reaction (Figure 6). It requires the target protein be less than 100 kDa in molecular weight and not capable of binding to IMAC resin. In practice, proteins less than 60 kDa are more readily purified using this procedure than proteins near the MW cut-off of the spin-column membrane. Additional equipment is necessary and includes: Ni-NTA Agarose (Qiagen), Amicon Ultracel 0.5 ml-100K spin concentrators. Figure 7 illustrates 2 examples.

1. Add 10 mM magnesium acetate or other diluent to the reaction to increase the volume and make handling of the sample easier.

We recommend a minimum volume of 100 μ l after dilution to minimize losses during purification. If the target will be too dilute after addition of the diluent, we suggest a larger reaction volume be used. Use of concentrated NaCl to dilute the reaction may help dissociate complexes between the target protein and translation factors. The NaCl will remain, however, after the final elution and downstream applications may require microdialysis. We suggest limiting the final concentration of NaCl to ≤ 0.4 M after dilution. Additionally, magnesium acetate should be included to keep $[Mg^{2+}]$ close to 10 mM.

2. Apply the diluted reaction mixture to a Amicon Ultracel 0.5 ml-100K spin concentrator (0.5 ml maximum load volume) and centrifuge for 30–60 min at 1,500 x g at 4°C. If necessary, higher centrifuged forces can be used to push the mixture through the membrane up to the recommended limit of concentration used.
3. Transfer the permeate/flow-through to a new tube, preferably a 2-ml round-bottom microfuge tube with a leak-proof cap.
4. Add 0.25 volumes Ni-NTA Agarose and mix thoroughly for 30–45 min at 4°C to allow His-tagged components to bind the resin.
5. Apply the reaction mixture slurry to an empty Bio-Rad micro-spin column and centrifuge for 2 min at 1500 xg at 4°C.
6. Collect eluate containing purified protein and proceed with experimental analysis.

Figure 6: Schematic diagram of protein synthesis and purification by PURExpress.

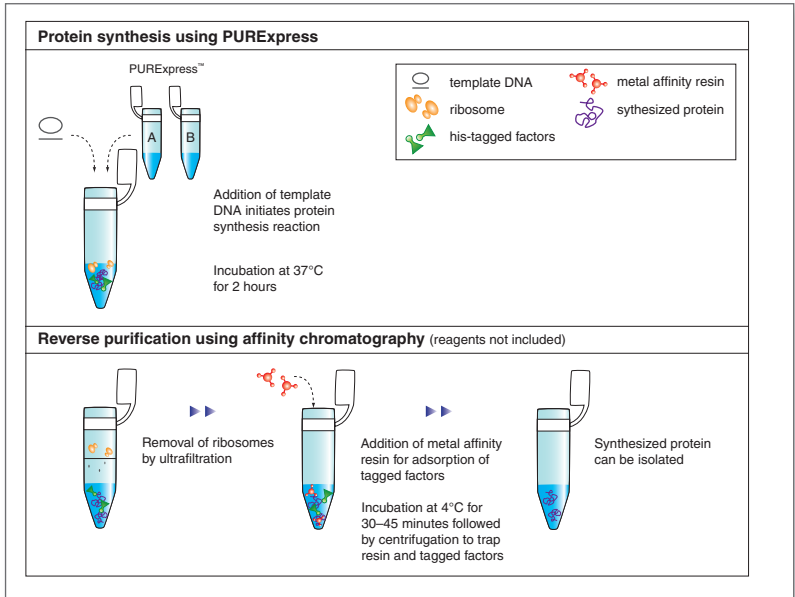
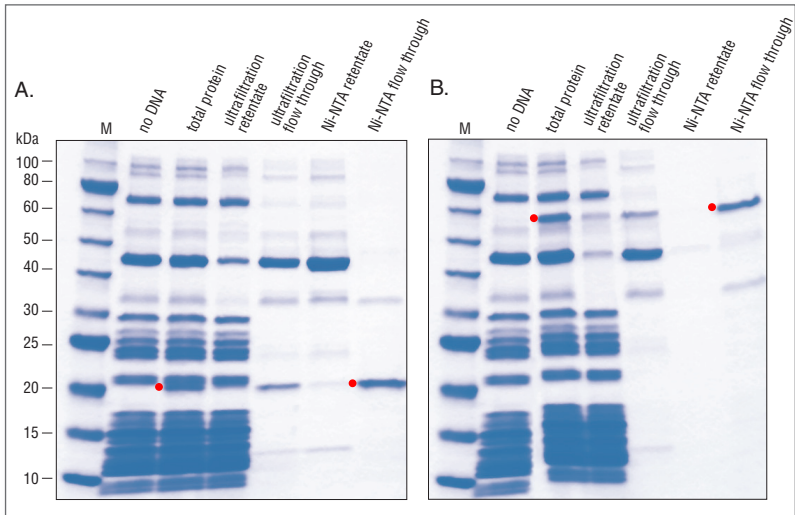

Figure 7: Expression and reverse purification of DHFR (A) and T4 DNA Ligase (B) using PURExpress.



125 μ l reactions were carried out according to recommendations in the accompanying manual. Samples were analyzed on a 10–20% Tris-glycine gel and stained with Coomassie Blue. Note that in both cases, the desired protein can be visualized in the total protein fraction. The red dot indicates the protein of interest. Marker M is the Protein Ladder (NEB #P7703).

Troubleshooting:

(For a complete list of FAQ's, please visit our website, www.neb.com/nebecomm/products/faqproductE6800.asp)

1. Control protein is not synthesized.

1.1 Kit component(s) inactivated

Storage of all materials at -80°C is required and number of freeze-thaw cycles should be minimized.

1.2 Nuclease contamination

To avoid nuclease contamination, wear gloves and use nuclease-free tips and tubes. We also recommend adding Murine RNase Inhibitor (e.g. NEB #M0314) to reactions.

2. Control protein is synthesized, target sample is not present or present in low yield.

2.1 RNase contamination

Commercial mini-prep kits are a useful tool for the preparation of template DNA but are often the source of introducing RNaseA to the *in vitro* protein synthesis reaction. See our guidelines template DNA preparation (Page 6). The inclusion of Murine RNase Inhibitor (NEB #M0314, 20 units/25 μl reaction) often overcomes this problem.

2.2 Template DNA design is compromised

Ensure that the sequence of the template DNA is correct. The coding region as well as the regulatory sequences need to be correct and in-frame to ensure that translation is initiated properly and that a full-length product is made. Non-optimal regulatory sequences and/or spacing may adversely affect translational efficiency.

Translation initiation is a key step for successful protein synthesis. Secondary structure or rare codons at the beginning of the mRNA may compromise the initiation process and adversely affect protein synthesis. The addition of a good initiation region (e.g. first ten codons of maltose binding protein) may help, assuming that adding residues to the target sequence can be tolerated. Alternatively, using PCR to modify the 5' end of the target gene can be a successful strategy to eliminate secondary structural elements or rare codons.

2.3 Template DNA is contaminated

Inhibitors of transcription or translation may be present in the DNA. A simple mixing experiment (control DNA + target DNA, compared to control DNA alone) will reveal whether inhibitors are present. Inhibitors in the target DNA will reduce the yield of the control protein. Do not use DNA purified from agarose gels as they often contain inhibitors of translation (e.g. ethidium bromide). Residual SDS from plasmid preparation protocols is

another common contaminant and can be removed by phenol:chloroform extraction and ethanol precipitation. When performing ethanol precipitation we recommend the use of sodium acetate rather than ammonium acetate, a known inhibitor of translation. Be careful to remove all traces of ethanol.

Templates produced by PCR need to be free of non-specific amplification products. These contaminants may contain transcription signals and thus compete for and titrate out transcription and/or translation components. As a result, yields may suffer and unwanted truncated products may be produced.

2.4 Template DNA concentration is not optimal.

The concentration of template DNA is important since *in vitro* protein synthesis is a balance between transcription and translation. Too little template reduces the amount of actively translated mRNA while too much template results in the overproduction of mRNA and overwhelming of the translational apparatus. We recommend 250 ng of template DNA for a 25 μ l reaction. Optimization with different amounts of template DNA (e.g. 25–250 ng) may improve yield of a particular target protein.

If UV absorbance was used to calculate the concentration of the template DNA, be aware that RNA or chromosomal DNA will also absorb UV light. If your sample has significant amounts of RNA or chromosomal DNA, the actual amount of template DNA may be lower than the calculated amount. The 260 nm/280 nm ratio should be 1.8. Running some of the template DNA on an agarose gel may reveal the presence of other nucleic acids as well as any degradation or incorrect size of the template DNA.

3. Target protein synthesized but full-length product is not major species

3.1 Translation initiation and/or termination not correct

The production of full-length protein requires proper initiation and termination. Internal ribosome entry sites and/or premature termination can produce unwanted truncated proteins. Initiation at non-authentic AUG codons and premature termination are difficult to control. If many rare codons are present or the target has an unusually high percentage of a particular amino acid, supplementation of the “missing” tRNA may help.

Citations:

Recent Citations Using PURExpress:

Asahara, H. and Chong, S. (2010). *In vitro* genetic reconstruction of bacterial transcription initiation by coupled synthesis and detection of RNA polymerase holoenzyme. *Nucleic Acids Res.* 38(13): e141.

Barendt, P. A., Shah, N. A. et al. (2012). Broad-specificity mRNA-rRNA complementarity in efficient protein translation. *PLoS Genet.* 8(3): e1002598.

Bruder, J., Siewert, K. et al. (2012). Target Specificity of an Autoreactive Pathogenic Human γ delta-T Cell Receptor in Myositis. *J. Biol. Chem.* 287(25): 20986-20995.

Chadani, Y., Ito, K. et al. (2012). ArfA recruits RF2 to rescue stalled ribosomes by peptidyl-tRNA hydrolysis in *Escherichia coli*. *Mol. Microbiol.*

Clasquin, M. F., Melamud, E. et al. (2011). Riboneogenesis in yeast. *Cell* 145(6): 969-980.

De Masi, F., Grove, C. A. et al. (2011). Using a structural and logics systems approach to infer bHLH-DNA binding specificity determinants. *Nucleic Acids Res.* 39(11): 4553-4563.

Dembek, M., Reynolds, C. B. et al. (2012). Clostridium difficile cell wall protein CwpV undergoes enzyme-independent intramolecular autoproteolysis. *J. Biol. Chem.* 287(2): 1538-1544.

Do, P. M., Varanasi, L. et al. (2012). Mutant p53 cooperates with ETS2 to promote etoposide resistance. *Genes Dev.* 26(8): 830-845.

Feng, Y. and Cronan, J. E. (2009). A new member of the *Escherichia coli* *fad regulon*: transcriptional regulation of *fadM* (*ybaW*). *J. Bacteriol.* 191(20): 6320-6328.

Feng, Y. and Cronan, J. E. (2011). Complex binding of the FabR repressor of bacterial unsaturated fatty acid biosynthesis to its cognate promoters. *Mol. Microbiol.* 80(1): 195-218.

Garza-Sanchez, F., Schaub, R. E. et al. (2011). tmRNA regulates synthesis of the ArfA ribosome rescue factor. *Mol. Microbiol.* 80(5): 1204-1219.

Ge, X., Luo, D. et al. (2011). Cell-free protein expression under macromolecular crowding conditions. *PLoS One* 6(12): e28707.

Gordan, R., K. F. Murphy, et al. (2011). Curated collection of yeast transcription factor DNA binding specificity data reveals novel structural and gene regulatory insights. *Genome Biol.* 12(12): R125.

Gordon, B. R., Li, Y. et al. (2011). Structural basis for recognition of AT-rich DNA by unrelated xenogeneic silencing proteins. *Proc. Natl. Acad. Sci. U.S.A.* 108(26): 10690-10695.

Guarino, C. and DeLisa, M. P. (2012). A prokaryote-based cell-free translation system that efficiently synthesizes glycoproteins. *Glycobiology* 22(5): 596-601.

Handa, Y., Inaho, N. et al. (2011). YaeJ is a novel ribosome-associated protein in *Escherichia coli* that can hydrolyze peptidyl-tRNA on stalled ribosomes. *Nucleic Acids Res.* 39(5): 1739-1748.

Harvey, C. J., Puglisi, J. D. et al. (2012). Precursor directed biosynthesis of an orthogonally functional erythromycin analogue: selectivity in the ribosome macrolide binding pocket. *J. Am. Chem. Soc.* 134(29): 12259-12265.

Iizuka, R., Yamagishi-Shirasaki, M. et al. (2011). Kinetic study of de novo chromophore maturation of fluorescent proteins. *Anal. Biochem.* 414(2): 173-178.

- Kaiser, C. M., Goldman, D. H. et al. (2011). The ribosome modulates nascent protein folding. *Science* 334(6063): 1723-1727.
- Karig, D. K., Iyer, S. et al. (2012). Expression optimization and synthetic gene networks in cell-free systems. *Nucleic Acids Res.* 40(8): 3763-3774.
- Kihara, F., Niimi, T. et al. (2011). Heat shock factor binds to heat shock elements upstream of heat shock protein 70a and Samui genes to confer transcriptional activity in *Bombyx mori diapause* eggs exposed to 5 degrees C. *Insect Biochem. Mol. Biol.* 41(11): 843-851.
- Kriechbaumer, V., Wang, P. et al. (2012). Alternative splicing of the auxin biosynthesis gene YUCCA4 determines its subcellular compartmentation. *Plant J.* 70(2): 292-302.
- Kumar, R. and Rao, D. N. (2011). A nucleotide insertion between two adjacent methyltransferases in *Helicobacter pylori* results in a bifunctional DNA methyltransferase. *Biochem. J.* 433(3): 487-495.
- Lam, K. N., van Bakel, H. et al. (2011). Sequence specificity is obtained from the majority of modular C2H2 zinc-finger arrays. *Nucleic Acids Res.* 39(11): 4680-4690.
- Lamichhane, T. N., Abeydeera, N. D. et al. (2011). Selection of peptides targeting helix 31 of bacterial 16S ribosomal RNA by screening M13 phage-display libraries. *Molecules* 16(2): 1211-1239.
- Machida, K., Masutani, M. et al. (2012). Reconstitution of the human chaperonin CCT by co-expression of the eight distinct subunits in mammalian cells. *Protein Expr. Purif.* 82(1): 61-69.
- Mallam, A. L. and Jackson, S. E. (2012). Knot formation in newly translated proteins is spontaneous and accelerated by chaperonins. *Nat. Chem. Biol.* 8(2): 147-153.
- Midon, M., Schafer, P. et al. (2011). Mutational and biochemical analysis of the DNA-entry nuclease EndA from *Streptococcus pneumoniae*. *Nucleic Acids Res.* 39(2): 623-634.
- Narayan, V., Pion, E. et al. (2011). Docking-dependent ubiquitination of the interferon regulatory factor-1 tumor suppressor protein by the ubiquitin ligase CHIP. *J. Biol. Chem.* 286(1): 607-619.
- Nicolini, C., Bragazzi, N. et al. (2012). Nanoproteomics enabling personalized nanomedicine. *Adv. Drug Deliv. Rev.*
- Noto, T., Kurth, H. M. et al. (2010). The Tetrahymena argonaute-binding protein Giw1p directs a mature argonaute-siRNA complex to the nucleus. *Cell* 140(5): 692-703.
- Ohtsuka, T., Neki, S. et al. (2011). Synthesis and *in situ* insertion of a site-specific fluorescently labeled membrane protein into cell-sized liposomes. *Anal. Biochem.* 418(1): 97-101.
- Ong, H. J., Siau, J. W. et al. (2012). Analysis of p53 binding to DNA by fluorescence imaging microscopy. *Micron.* 43(9): 996-1000.
- Panayiotou, C., Solaroli, N. et al. (2011). The characterization of human adenylate kinases 7 and 8 demonstrates differences in kinetic parameters and structural organization among the family of adenylate kinase isoenzymes. *Biochem. J.* 433(3): 527-534.
- Ramu, H., Vazquez-Laslop, N. et al. (2011). Nascent peptide in the ribosome exit tunnel affects functional properties of the A-site of the peptidyl transferase center. *Mol. Cell* 41(3): 321-330.
- Rosner, K., Kasprzak, M. F. et al. (2011). Engineering a waste management enzyme to overcome cancer resistance to apoptosis: adding DNase1 to the anti-cancer toolbox. *Cancer Gene Ther.* 18(5): 346-357.

- Sanei, M., Pickering, R. et al. (2011). Loss of centromeric histone H3 (CENH3) from centromeres precedes uniparental chromosome elimination in interspecific barley hybrids. *Proc. Natl. Acad. Sci. U.S.A.* 108(33): E498-505.
- Shen, B. W., Heiter, D. F. et al. (2010). Unusual target site disruption by the rare-cutting HNH restriction endonuclease Pacl. *Structure* 18(6): 734-743.
- Shi, W., Zhang, X. et al. (2011). Pyrazinamide inhibits trans-translation in *Mycobacterium tuberculosis*. *Science* 333(6049): 1630-1632.
- Siggers, T., Duyzend, M. H. et al. (2011). Non-DNA-binding cofactors enhance DNA-binding specificity of a transcriptional regulatory complex. *Mol. Syst. Biol.* 7: 555.
- Solaroli, N., Panayiotou, C. et al. (2009). Identification of two active functional domains of human adenylate kinase 5. *FEBS Lett.* 583(17): 2872-2876.
- Stogbauer, T., Windhager, L. et al. (2012). Experiment and mathematical modeling of gene expression dynamics in a cell-free system. *Integr. Biol. (Camb)* 4(5): 494-501.
- Talabot-Ayer, D., Lamacchia, C. et al. (2009). Interleukin-33 is biologically active independently of caspase-1 cleavage. *J. Biol. Chem.* 284(29): 19420-19426.
- Tanner, D. R., Cariello, D. A. et al. (2009). Genetic identification of nascent peptides that induce ribosome stalling. *J. Biol. Chem.* 284(50): 34809-34818.
- Theerthagiri, G., Eisenhardt, N. et al. (2010). The nucleoporin Nup188 controls passage of membrane proteins across the nuclear pore complex. *J. Cell Biol.* 189(7): 1129-1142.
- Vazquez-Laslop, N., Ramu, H. et al. (2010). The key function of a conserved and modified rRNA residue in the ribosomal response to the nascent peptide. *EMBO J.* 29(18): 3108-3117.
- Vázquez-Laslop, N., Ramu, H. et al. (2011). Nascent peptide-mediated ribosome stalling promoted by antibiotics. *Ribosomes*. M. Rodnina, W. Wintermeyer and R. Green, Springer Vienna: 377-392.
- Venancio-Marques, A., Liu, Y.-J. et al. (2012). Modification-Free Photocontrol of β -Lactam Conversion with Spatiotemporal Resolution. *ACS Synthetic Biology*.
- Wang, H. H., Huang, P. Y. et al. (2012). Multiplexed *in vivo* His-tagging of enzyme pathways for *in vitro* single-pot multi-enzyme catalysis. *ACS Synth. Biol.* 1(2): 43-52.
- Xu, S. Y., Nugent, R. L. et al. (2012). Characterization of type II and III restriction-modification systems from *Bacillus cereus* strains ATCC 10987 and ATCC 14579. *J. Bacteriol.* 194(1): 49-60.
- Yamamoto, S., Izumiya, H. et al. (2011). Identification of a chitin-induced small RNA that regulates translation of the *tfoX* gene, encoding a positive regulator of natural competence in *Vibrio cholerae*. *J. Bacteriol.* 193(8): 1953-1965.
- Zhu, X., Ahmad, S. M. et al. (2012). Differential regulation of mesodermal gene expression by *Drosophila* cell type-specific Forkhead transcription factors. *Development* 139(8): 1457-1466.

*Please see our website for the most up to date publication list.

Citations Using PURE System:

Ohashi, H., Kanamori, T. et al. (2010). A highly controllable reconstituted cell-free system--a breakthrough in protein synthesis research. *Curr. Pharm. Biotechnol.* 11(3): 267-271.

Shimizu, Y., Inoue, A. et al. (2001). Cell-free translation reconstituted with purified components. *Nat. Biotechnol.* 19(8): 751-755.

Shimizu, Y., Kanamori, T. et al. (2005). Protein synthesis by pure translation systems. *Methods* 36(3): 299-304.

Shimizu, Y., Kuruma, Y. et al. (2006). Cell-free translation systems for protein engineering. *FEBS J.* 273(18): 4133-4140.

Shimizu, Y. and Ueda, T. (2010). PURE technology. *Methods Mol. Biol.* 607: 11-21.

Ordering Information

PRODUCT	NEB #	SIZE
PURExpress <i>In Vitro</i> Protein Synthesis Kit	E6800S/L	10/100 reactions
PURExpress Δ Ribosome Kit	E3313S	10 reactions
PURExpress Disulfide Bond Enhancer	E6820S	50 reactions
PURExpress Δ (aa, tRNA) Kit	E6840S	10 reactions
PURExpress Δ RF123 Kit	E6850S	10 reactions
COMPANION PRODUCTS		
RNase Inhibitor, Murine	M0314S/L	3,000/15,000 units
<i>E. coli</i> Ribosome	P0763S	1 mg



USA

New England Biolabs, Inc.
240 County Road
Ipswich, MA 01938-2723
Telephone: (978) 927-5054
Toll Free: (USA Orders) 1-800-632-5227
Toll Free: (USA Tech) 1-800-632-7799
Fax: (978) 921-1350
e-mail: info@neb.com
www.neb.com

Canada

New England Biolabs, Ltd.
Telephone: (905) 837-2234
Toll Free: 1-800-387-1095
Fax: (905) 837-2994
Fax Toll Free: 1-800-563-3789
e-mail: info@ca.neb.com

China, People's Republic

New England Biolabs (Beijing), Ltd.
Telephone: 010-82378265/82378266
Fax: 010-82378262
e-mail: info@neb-china.com

France

New England Biolabs France
Free Call: 0800/100 632
Free Fax: 0800/100 610
e-mail: info@fr.neb.com

Germany

New England Biolabs GmbH
Telephone: +49/(0)69/305 23140
Free Call: 0800/246 5227 (Germany)
Fax +49/(0)69/305 23149
Free Fax: 0800/246 5229 (Germany)
e-mail: info@de.neb.com

Japan

New England Biolabs Japan, Inc.
Telephone: +81 (0)3 5669 6191
Fax +81 (0)3 5669 6192
e-mail: info@neb-japan.com

United Kingdom

New England Biolabs (UK), Ltd.
Telephone: (01462) 420616
Call Free: 0800 318486
Fax: (01462) 421057
Fax Free: 0800 435682
e-mail: info@uk.neb.com



E6800S 00000000000